

Molding Power Choke



Integrated forming inductor independent mold opening, with a number of design patents, a number of independent knowledge products; Small volume, small current, can maintain good temperature rise current and saturation current characteristics at high temperature; Adopt one body forming structure, strong, magnetic circuit closed, with good magnetic shielding and EMI performance; Magnetic shield structure, magnetic circuit closed, strong anti-electromagnetic interference, with very low buzzer, high installation density; Low loss alloy powder die-casting, low impedance; High precision, durable rust prevention;

Features

- Products are lead-free, in line with RoHS directive, Halogen Free and REACH Compliance
- SMD surface mount inductor
- The integrated structure avoids noise
- Lowest DC impedance of the same size
- The current resistance inductance value drops to ensure smooth
- Up to 5MHz application frequency
- Fully enclosed magnetic shielding structure can effectively reduce electromagnetic interference

Applications

- DC-DC converters
- Power modules
- CONSUME
- Laptop, MOTHERBOARD,INDUSTRY
- Communication networks, Internet of Things and other electronic devices

Product Identification

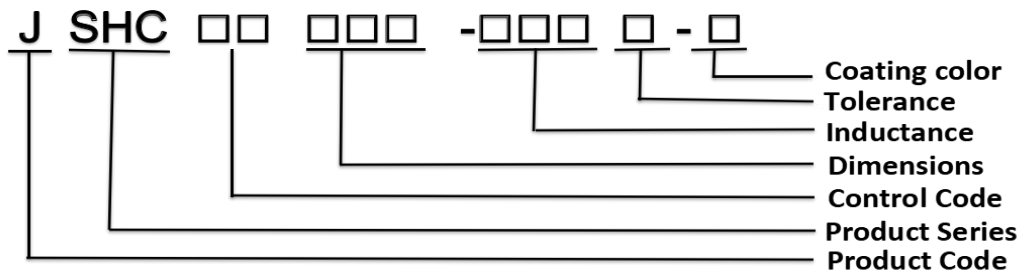

Appearance and dimensions

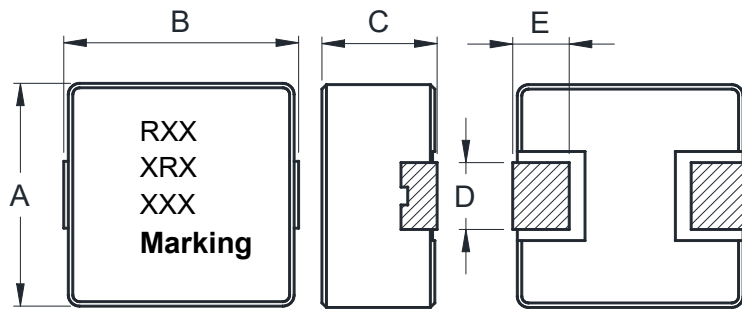

Reference PCB pattern

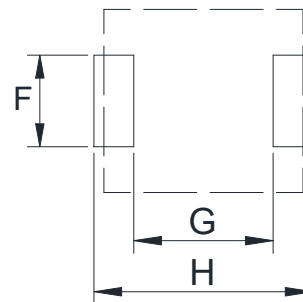

Schematic

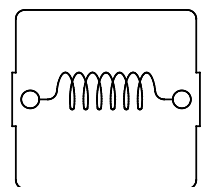

Dimensions in mm

A	B	C	D	E	F	G	H
4.5Max	4.5Max	2.0Max	1.5±0.5	1.0±0.3	2.5Ref	1.8Ref	4.8Ref

Electrical Characteristics

Part Number	Inductance	Tolerance	Test Frequency	RDC(m Ω)	Isat(A)	Irms(A)
	(μ H)	(\pm %)	(KHz)	Max(Typical)	Typical(Max)	Typical(Max)
JSHC0420H-R22M-K	0.22	20	100	8(7.2)	12.0(10.8)	9.0(8.1)
JSHC0420H-R33M-K	0.33	20	100	12(10.8)	10.5(9.45)	8.0(7.2)
JSHC0420H-R47M-K	0.47	20	100	14(12.6)	9.0(8.1)	5.5(4.95)
JSHC0420H-R56M-K	0.56	20	100	18(16.2)	9.5(8.55)	5.2(4.68)
JSHC0420H-R68M-K	0.68	20	100	21(18.9)	8.0(7.2)	5.0(4.5)
JSHC0420H-1R0M-K	1.0	20	100	27(24.3)	7.0(6.3)	4.5(4.05)
JSHC0420H-1R5M-K	1.5	20	100	36(32.4)	6.0(5.4)	4.0(3.6)
JSHC0420H-2R2M-K	2.2	20	100	58(52.2)	5.0(4.5)	3.0(2.7)
JSHC0420H-3R3M-K	3.3	20	100	90(81)	3.0(2.7)	2.0(1.8)
JSHC0420H-4R7M-K	4.7	20	100	150(135)	3.0(2.7)	2.0(1.8)
JSHC0420H-5R6M-K	5.6	20	100	160(144)	2.6(2.34)	2.0(1.8)
JSHC0420H-6R8M-K	6.8	20	100	170(153)	2.5(2.25)	2.0(1.8)
JSHC0420H-100M-K	10.0	20	100	200(180)	2.0(1.8)	1.5(1.35)

Note: When ordering, please specify tolerance code. Tolerance: M \pm 20%

- All data is tested on 25 $^{\circ}$ C ambient temperature.
- Inductance is tested at 100kHz, 1.0V.
- Heat rating current: The value of DC current when product temperature rise is $\Delta T 40^{\circ}$ C ($T_a=25^{\circ}$ C).
- Saturation current: The value of DC current when the inductance decreases approximately 30% of its.

Special remind: Circuit design, component placement, frequency, cooling system and etc. all will affect the product temperature. Please verify the actual product temperature in the final application.

Heat rating current VS saturation current curv

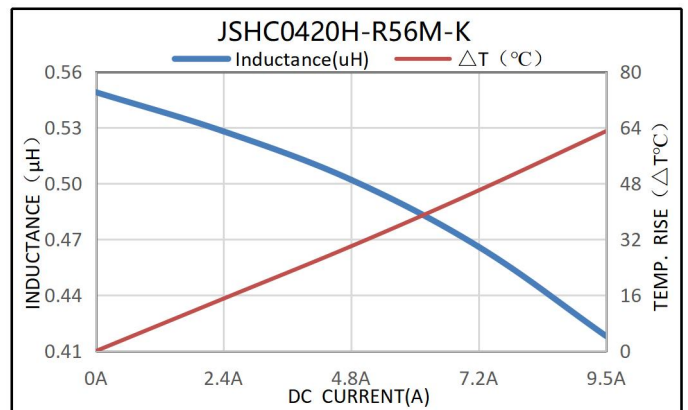
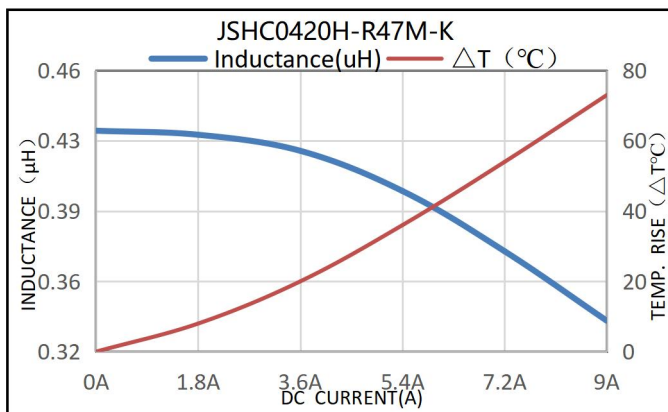
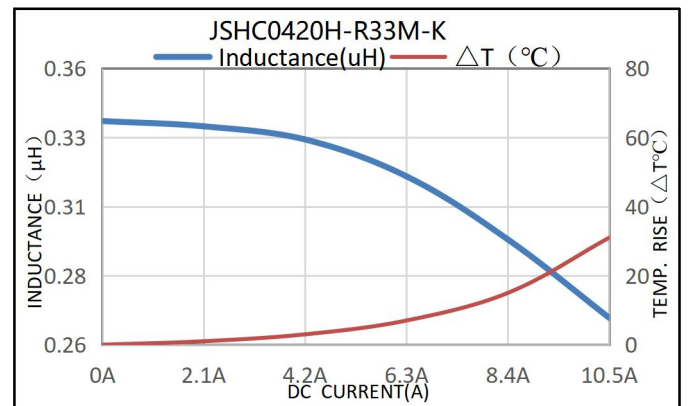
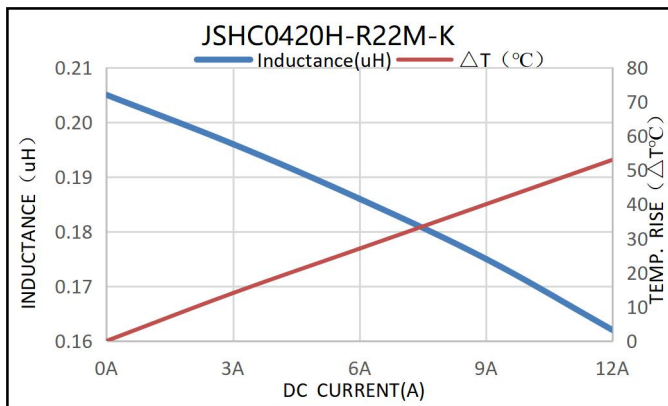

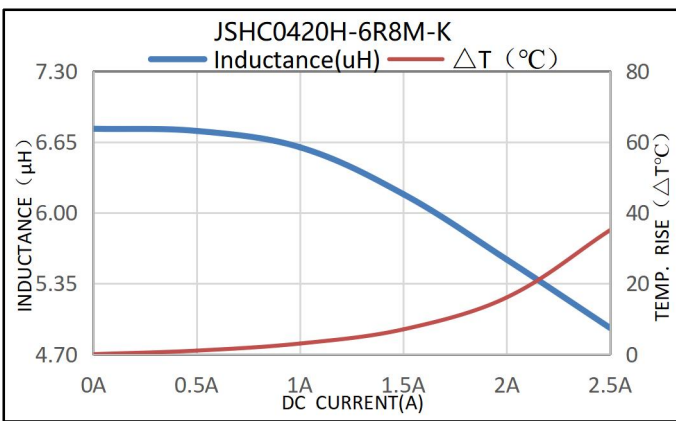
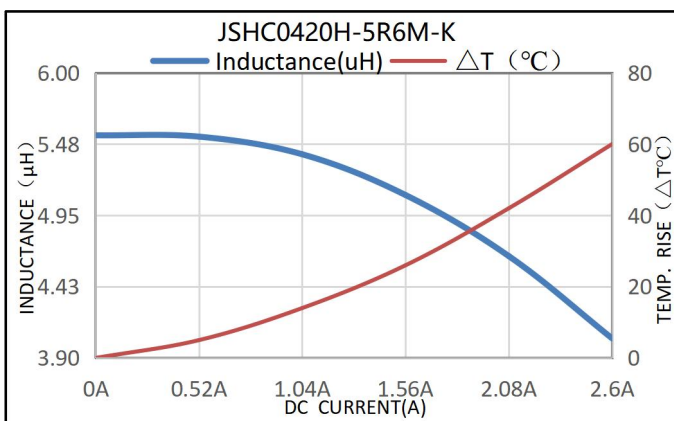
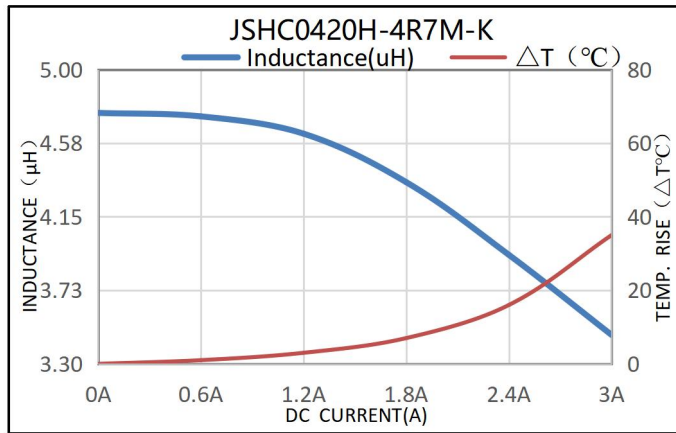
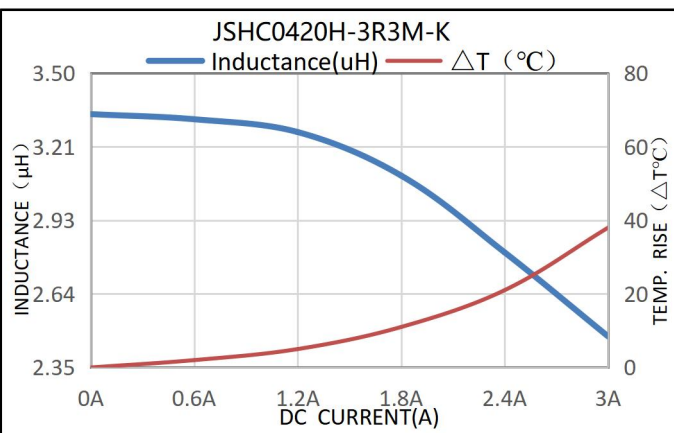
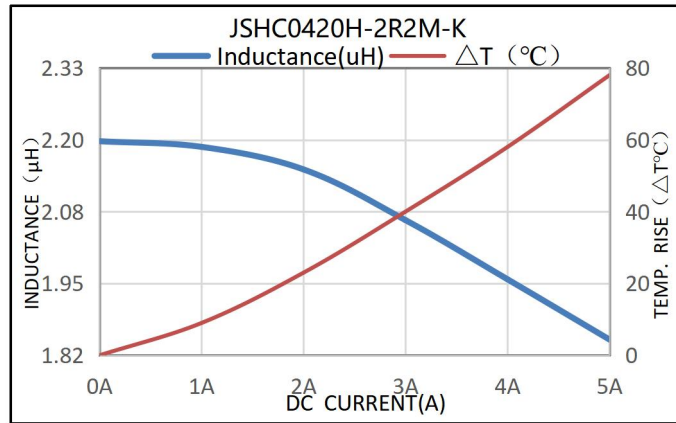
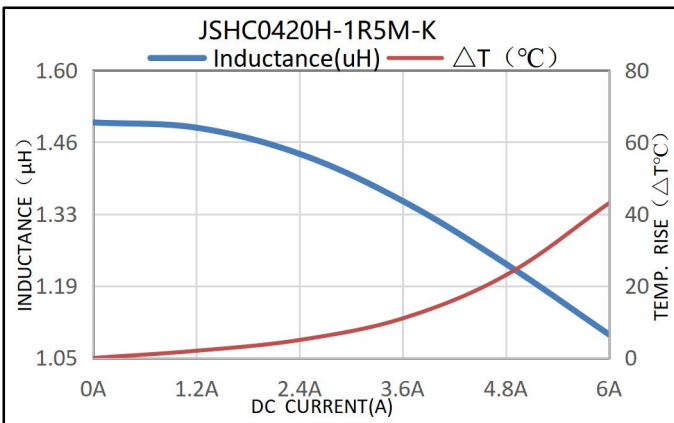
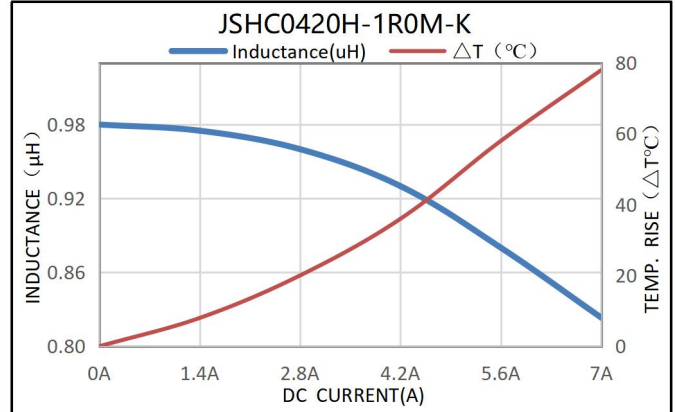
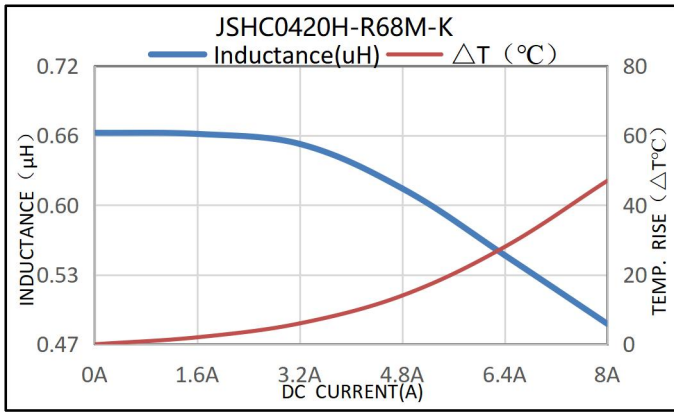

Packaging Specifications

Carrier tape dimensions

A0	4.35±0.2
B0	4.9±0.2
K0	2.25±0.1
W	12.0±0.3
P	8.0±0.2
F	5.50±0.1
T	0.35±0.05
D0	1.5±0.10

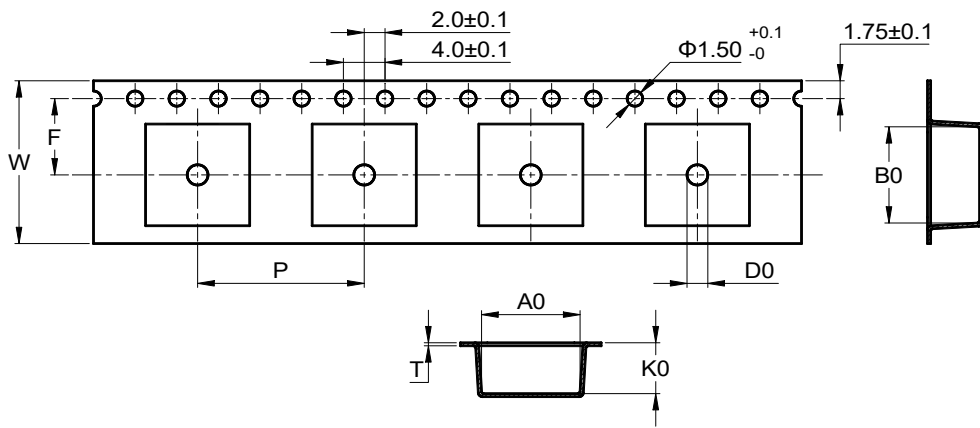

※ 包装参照国际标准 IEC 60286-3。

Packaging is referred to the international standard IEC 60286-3.

Packaging direction

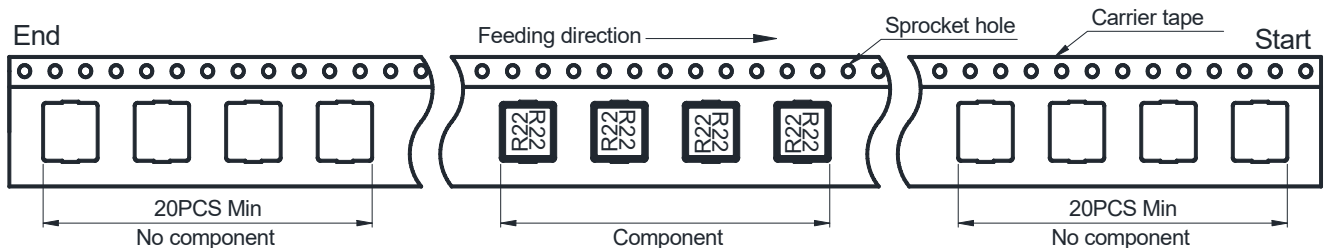

Reel dimensions

A	330 ± 2.0
B	100 Min
C	20.0Max
D	12.5 Min

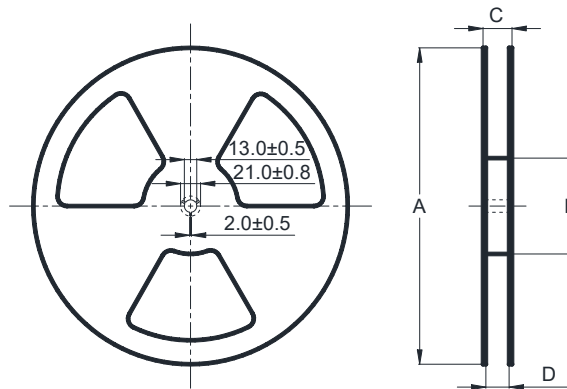

Cover tape peel-off condition

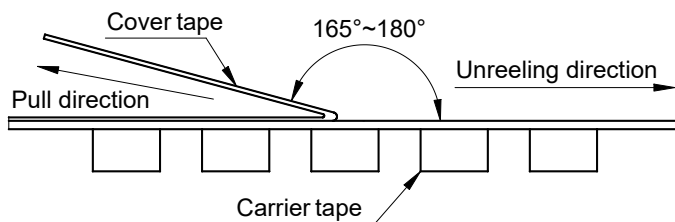
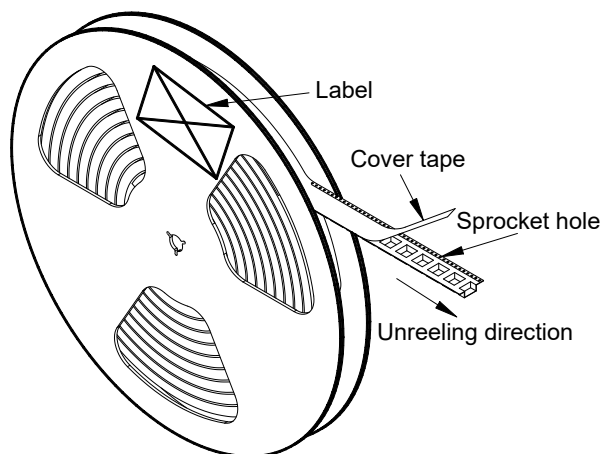

※ 盖带剥离力度为 0.1~1.3N。

Cover tape peel-off force will be 0.1 to 1.3N.

※ 参考剥离速度 300±10mm/分钟。

Reference peel-off speed 300±10mm/min.

Carton dimensions and packaging quantity

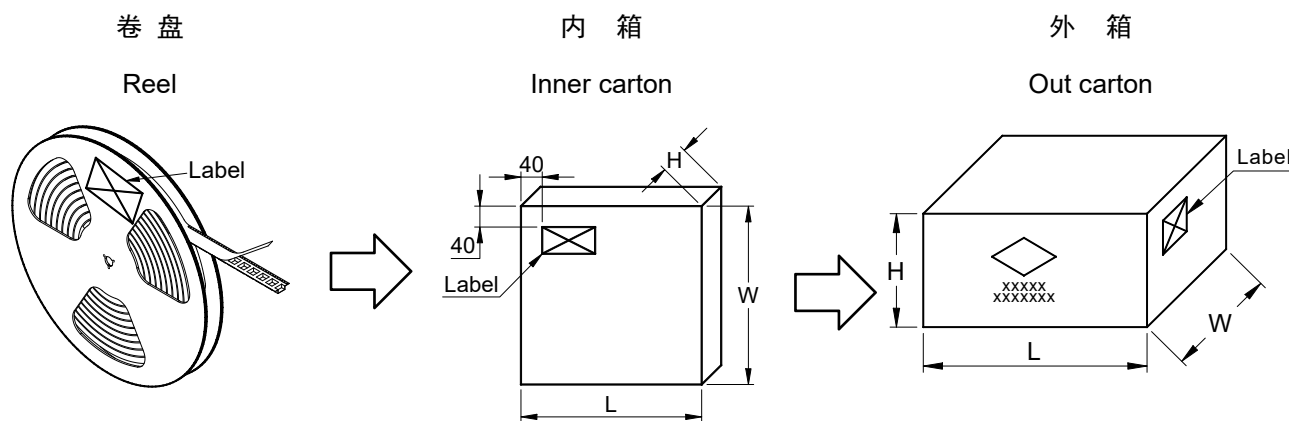

■ 内包装箱(L×W×H): 340×340×52mm
Inner Carton

■ 外包装箱(L×W×H): 354×354×176mm
Out Carton

SHC0420	每盘 包装数量 Per Reel Quatity	内箱 包装数量 Inner Carton Quatity	外箱 包装数量 Out Carton Quatity
	3,000 pcs	(3,000×2) = 6,000 pcs	(6,000×3) = 18,000 pcs